

Data Sheet



Article number: 432000170

Description: Rota-fix shaft-hub connection A 170x225
Steel

Note: Not self centering. Medium-high torques.

Measures

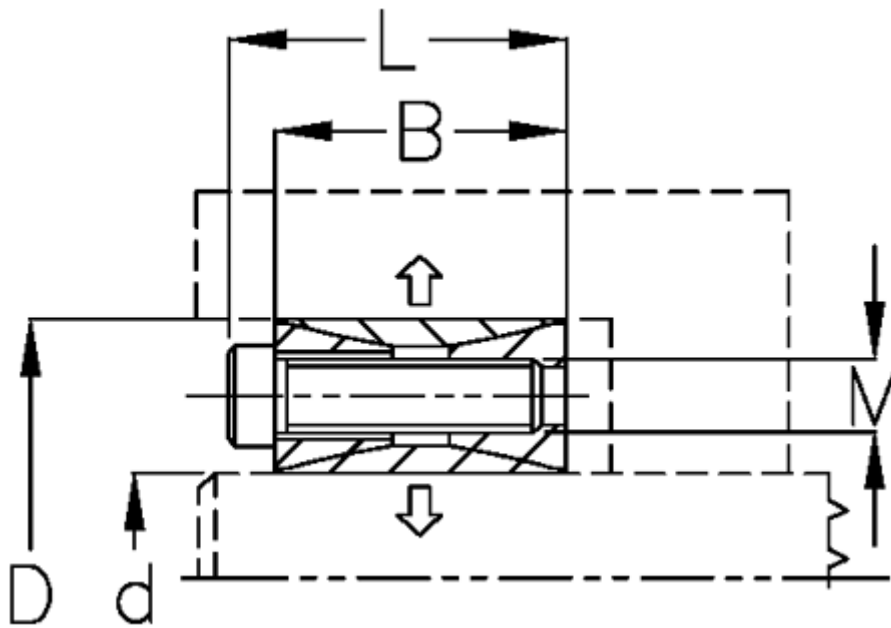

B mm	= 44
d H8 mm	= 170225
D mm	= 225
Fit tolerance	= Aksel k11-h11, Nav N11-H11
F kN torque	= 434.0
L mm	= 58
M mm	= M14
P N/mm ² surface pressure on shaft/hub	= 135

Surface roughness	=
T N m torque	=
Ts N m bolt tightening torque	=